

**Product Information**

**LABO-VHS-S**

**Flow Transmitter / Screw  
Volumeter LABO-VHS-S**



- Monitors viscous media (oil) 1.4..2500 l/min
- Connection G 1..G 2<sup>1</sup>/<sub>2</sub>
- Very low dependence on viscosity
- Can be used up to 40,000 mm<sup>2</sup>/s (cSt)
- Versatile configurable limit switch (push-pull)
- Light and compact device (aluminium housing)
- Operation and measurement possible with forward and reverse flow
- For cost-sensitive applications

**Characteristics**

The VHS flow transmitter measures the flow using the volumetric principle, and is suitable for fluid, viscous, lubricant media (e.g. lubricating oil). If the material for the VHS is selected appropriately, aqueous fluids such as soaps, pastes, and emulsions with non-abrasive characteristics can also be measured, as long as they have sufficient lubricity. Because of the volumetric functioning principle, the device is almost completely independent of viscosity.

The VHS system consists of two interlacing screws which run in opposite directions, driven by the flowing medium. A magnetically pre-tensioned Hall sensor positioned outside the flow space detects the screw flanks, and creates a frequency signal proportional to the flow. Here, every pulse corresponds to a specific measured volume. There are no magnets in the flow space.

The LABO-xxx-s electronics fitted to the device make available an electronic switching output (push-pull) with adjustable characteristics (minimum/maximum) and hysteresis, which responds when an adjustable limit is fallen short of or exceeded. If desired, the switching value can be set to the currently existing flow using "teaching". Models with analog or pulse output are also available (see separate data sheets).

**Technical data**

<b>Sensor</b>	screw volumeter		
<b>Nominal width</b>	DN 25..65		
<b>Process connection</b>	female thread G 1..G 2 <sup>1</sup> / <sub>2</sub>		
<b>Switching ranges</b>	see table "Ranges and weights"		
<b>Measurement accuracy</b>	±1 % of the measured value (at 20 mm <sup>2</sup> /s, (cSt) of 1 %..100 % nominal working range (see also diagram in upstream pages)		
<b>Repeatability</b>	±0,25 %		
<b>Pressure resistance</b>	<b>Connection material</b>	<b>SAE flange</b>	<b>PN bar</b>
	Aluminium	without	160
	Aluminium	with	350
	Steel	without	350
	Steel	with	350
	others available on request		
<b>Pressure loss</b>	see diagram in upstream pages		
<b>Medium</b>	oil or non-aggressive self-lubricating fluids		
<b>Medium temperature</b>	-25..+80 °C (150 °C available on request)		
<b>Materials medium-contact</b>	(special materials available on request):		
<b>1. Body</b>	Aluminium 6082 anodised		
<b>2. Connections:</b>	Aluminium 6082 anodised or steel		
<b>3. Main screw</b>	Steel 35SMnPb10 UNI 4838-80		
<b>4. Subsidiary screw</b>	GHISA GJL-250 EN1561		
<b>5. Ball bearing</b>	Steel		
<b>6. Ball bearing</b>	Steel		
<b>7. Screws</b>	Galvanised steel		
<b>8. O-ring</b>	NBR		
<b>9. Seeger ring</b>	Steel		
<b>10. Seeger ring</b>	Steel		
<b>11. O-ring</b>	NBR		
<b>12. SAE connection</b>	ASTM A216WCB		
<b>13. SAE flange</b>	ASTM A216WCB		
<b>14. O-ring</b>	NBR		
<b>15. Screws</b>	Galvanised steel		
<b>16. Sensor spacer</b>	Aluminium 6082 anodised		
<b>Materials, non-medium-contact</b>	Sensor tube:	CW614N nickelled	
	Adhesive:	epoxy resin	
	Flange bolts:	stainless steel	
<b>Supply voltage</b>	10..30 V DC		
<b>Power consumption</b>	< 1 W (for no-load outputs)		

**Product Information**

<b>Switching output</b>	transistor output "push-pull" (resistant to short circuits and reversed polarity protected) $I_{out} = 100$ mA max.
<b>Display</b>	yellow LED (On = Normal / Off = Alarm / rapid flashing = Programming)
<b>Electrical connection</b>	for round plug connector M12x1, 4-pole
<b>Ingress protection</b>	IP 67
<b>Weight</b>	see table "Ranges and weights"
<b>Conformity</b>	CE

**Ranges and weights**

● = Standard ○ = Option

G	DN	● / ○	Metering range 1..100 % $Q_{nom}$	Volume / pulse cm <sup>3</sup>	Types	$Q_{max}$ recommended	Weights		
							Body with aluminium connections kg	Body with steel connections kg	SAE Flanges (Weight per pair) kg
G 1	DN 25	●	1.4.. 140	13.10	LABO-VHS-025...0140	200	3.44	4.76	5.76
G 1 <sup>1</sup> / <sub>4</sub>	DN 32	●	3.5.. 350	29.00	LABO-VHS-032...0350	500	6.35	8.50	9.55
G 1 <sup>1</sup> / <sub>2</sub>	DN 40	○	5.5.. 550	48.58	LABO-VHS-040...0550	800	10.50	13.60	15.10
		●	8.0.. 800	72.00	LABO-VHS-040...0800	1200	14.20	18.50	18.80
G 2	DN 50	○	10.0..1000	103.63	LABO-VHS-050...1000	1600	20.70	27.70	30.30
		●	15.0..1500	133.00	LABO-VHS-050...1500	2200	25.00	33.20	34.60
G 2 <sup>1</sup> / <sub>2</sub>	DN 65	●	25.0..2500	238.82	LABO-VHS-065...2500	3800	42.70	56.10	60.70

**Wiring**

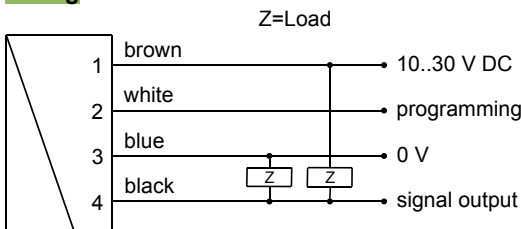

Connection example: PNP NPN

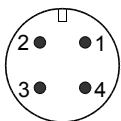

Before the electrical installation, it must be ensured that the supply voltage corresponds to the data sheet.  
It is recommended to use shielded wiring.  
The push-pull output) can as desired be switched as a PNP or an NPN output.

**Product Information**

**LABO-VHS-S**

**Dimensions**

● = Standard ○ = Option

							VHS-...GAO...				VHS-...GAX...			
G	DN	x1	L1	ØD	SW	A	M	x2	B	C	L2	H	E	F
G 1	025...0140	● 20	220	88	78	49.0	12	20	57.1	27.8	324	52	80	69
G 1¼	032...0350	● 22	285	103	-	55.0	14	22	66.7	31.6	381	48	94	77
G 1½	040...0550	○ 24	332	122	-	58.8	16	24	79.4	36.5	448	58	106	89
		● 340	340	138	-	66.5					456			
G 2	050...1000	○ 33	396	155	-	71.0	20	35	96.8	44.4	544	74	135	116
		● 405	405	168	-	77.3					553			
G 2½	065...2500	● 35	475	203	-	86.0	24	42	123.8	58.7	633	79	166	150

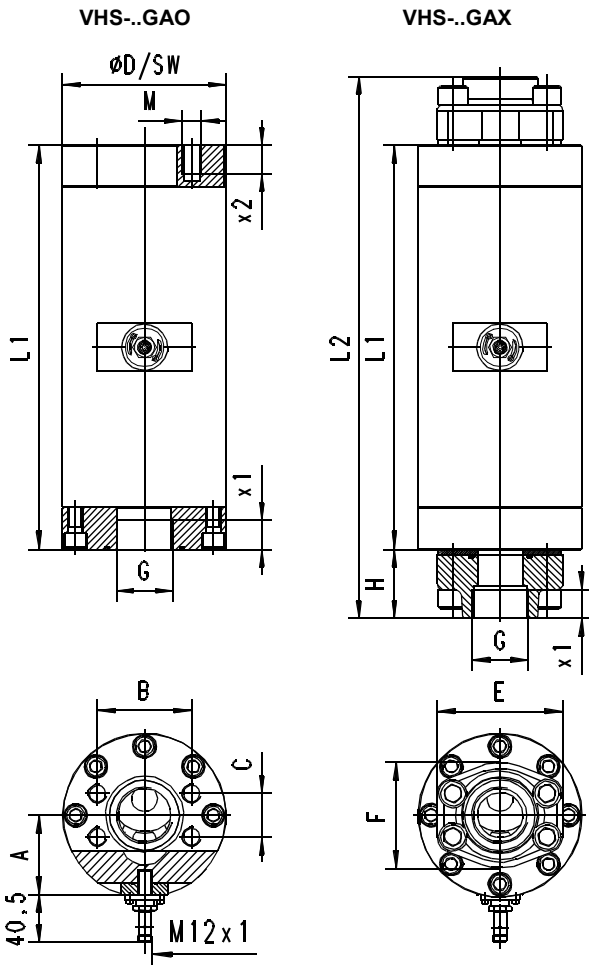

**SAE adapter for convenient installation and for increased stability to pressure! (350 bar)**

**Handling and operation**

**Installation**

Any flow direction is possible during installation. Ensure that pipework is clean. Flush before installation. A 30 µm mesh filter should be used. The use of SAE flanges enables the sensor to be installed and removed more easily, and increases the stability to pressure to 350 bar for every connection material.

It is possible to replace the electronics during operation, and this presents no danger to the fitter. The sensor does not go into the flow space.

**Note**

The switching value can be programmed by the user via "teaching". If desired, programmability can be blocked by the manufacturer. The ECI-1 device configurator with associated software is available as a convenient option for programming all parameters by PC, and for adjustment.

**Product Information**

**Operation and programming**

The switching value is set as follows:

- Apply the flow rate to be set to the device.
- Apply an impulse of at least 0.5 seconds and max. 2 seconds duration to pin 2 (e.g. via a bridge to the supply voltage or a pulse from the PLC), in order to accept the measured value.
- When the teaching is complete, pin 2 should be connected to 0 V, so as to prevent unintended programming.

The device has a yellow LED which flashes during the programming pulse. During operation, the LED serves as a status display for the switching output. In order to avoid the need to transit to an undesired operating status during the teach-in, the device can be provided ex-works with a teach-offset. The teach-offset point is added to the currently measured value before saving. The offset point can be positive or negative.

*Example: The switching value should be set to 80 %. However, it is possible only to reach 60 % without problems. In this case, the device would be ordered with a "teach-offset" of +20%.. At a flow rate of 60 % in the process, teaching would then store a value of 80 %.*

The limit switch can be used for monitoring minimal or maximal.

With a minimum-switch, falling below the limit value causes a switchover to the alarm state. Return to the normal state occurs when the limit value plus the set hysteresis is once more exceeded.

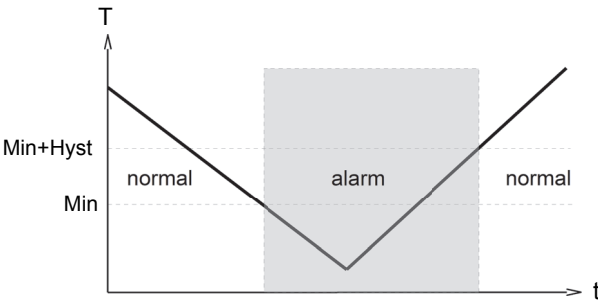

With a maximum-switch, exceeding the limit value causes a switchover to the alarm state. Return to the normal state occurs when the measured value once more falls below the limit value minus the set hysteresis.

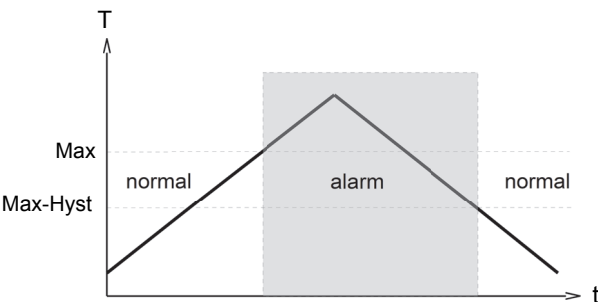

A switchover delay time ( $t_{DS}$ ) can be applied to the switchover to the alarm state. Equally, one switch-back delay time ( $t_{DR}$ ) of several can be applied to switching back to the normal state.

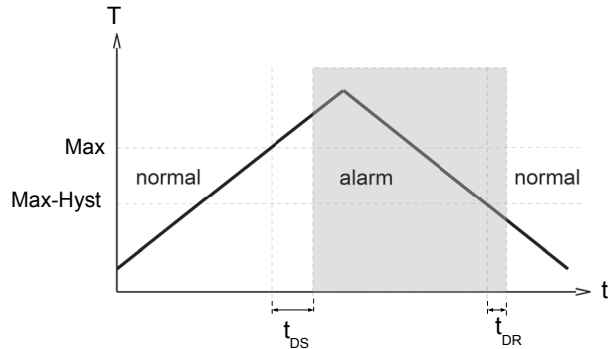

In the normal state the integrated LED is on, in the alarm state it is off, and this corresponds to its status when there is no supply voltage.

In the non-inverted (standard) model, while in the normal state the switching output is at the level of the supply voltage; in the alarm state it is at 0 V, so that a wire break would also display as an alarm state at the signal receiver. Optionally, an inverted switching output can also be provided, i.e. in the normal state the output is at 0 V, and in the alarm state it is at the level of the supply voltage.

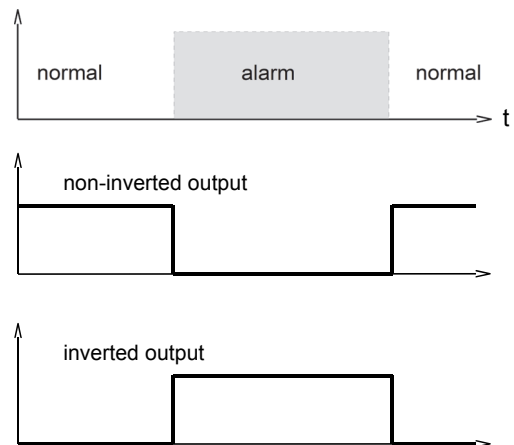

A Power-On-Delay function (ordered as a separate option) makes it possible to maintain the switching output in the normal state for a defined period after application of the supply voltage.

**Product Information**

**LABO-VHS-S**

**Ordering code**

VHS - 1. 2. 3. 4. 5. 6. 7. 8.  
  **G**   **A**   **E**

LABO - VHS - 9. 10. 11. 12. 13. 14. 15.  
  **S**    **S**

○=Option

<b>1. Nominal width</b>									
025	DN 25 - G 1								
032	DN 32 - G 1¼								
040	DN 40 - G 1½								
050	DN 50 - G 2								
065	DN 65 - G 2½								
<b>2. Process connection</b>									
G	female thread								
<b>3. Connection material</b>									
A	AL connection, anodised (160 bar, in combination with SAE flange: 350 bar)								
S	○ Connection, steel (350 bar)								
<b>4. Additional flange</b>									
X	SAE flange, steel (350 bar)								
O	no SAE flange								
<b>5. Body material</b>									
A	anodised aluminium								
<b>6. Metering range</b>									
0140	1.4.. 140 l/min								●
0350	3.5.. 350 l/min								●
0550	○ 5.5.. 550 l/min								●
0800	8.0.. 800 l/min								●
1000	○ 10.0..1000 l/min								●
1500	15.0..1500 l/min								●
2500	25.0..2500 l/min								●
<b>7. Seal material</b>									
N	NBR								
V	○ FKM								
<b>8. Connection for</b>									
E	electronics								
<b>9. For nominal width</b>									
025	DN 25 - G 1								●
032	DN 32 - G 1¼								●
040	DN 40 - G 1½								●
050	DN 50 - G 2								●
065	DN 65 - G 2½								●
<b>10. Switching output (Limit switch)</b>									
S	push-pull (compatible with PNP and NPN)								
<b>11. Programming</b>									
P	programmable (teaching possible)								
N	○ cannot be programmed (no teaching)								
<b>12. Switching function</b>									
L	minimum switch								
H	maximum switch								
<b>13. Switching signal</b>									
O	standard								
I	○ inverted								
<b>14. Electrical connection</b>									
S	for round plug connector M12x1, 4-pole								
<b>15. Optional</b>									
H	○ 150 °C with electronics separated by 30 cm								

**Required ordering information**

**For LABO-VHS-F:**  
**Output frequency at full scale**  Hz  
Maximum value: 2.000 Hz

**For LABO-VHS-C:**  
For the pulse output version, the volume (with numerical value and unit) which will correspond to one pulse must be stated.

**Volume per pulse (numerical value)**

**Volume per pulse (unit)**

**Options**

**Special range for analog output:**  l/min  
<= metering range (standard=metering range)

**Special range for frequency output:**  l/min  
<= metering range (standard=metering range)

**Power-On-Delay period (0..99 s)**  s  
(time after applying power during which the outputs are not activated or set to defined values)

Further options available on request.

**Accessories**

- Cable/round plug connector (KB...) see additional information "Accessories"
- Converter / counter OMNI-TA
- Device configurator ECI-1